

evluma

AreaMax™

available with
ConnectLED™



evluma

AREAMAX™

The AreaMax is Evluma's premier LED luminaire for area and security lighting. The AreaMax introduces a revolutionary new way to deliver dusk-till-dawn efficiency by reducing your dependence on the traditional photocontrol. Affordable and easy to install, the AreaMax slides onto the existing pole arm typically used by NEMA Type V dusk-till-dawn fixtures. As high as 93 lm/W for the entire system, the AreaMax is a recommended LED replacement for the average 100-175W HID fixture. Order the AreaMax with ConnectLED and take advantage of additional maintenance and energy savings with dimming features and remote commissioning/decommissioning.

Photocontrol Failsafe Mode™

The AreaMax introduces a revolutionary new way to deliver dusk-till-dawn efficiency with a built-in Photocontrol Failsafe Mode. Compatible with NEMA standard twist-lock photocontrols, place the AreaMax in the field with a photocontrol installed. Over time, an internal processor will calibrate the AreaMax to its unique geographic times for sunrise and sunset. Should the photocontrol fail, the AreaMax will take over based on the information it has collected eliminating a maintenance visit and guaranteeing continuous operation. The AreaMax is also compatible with wireless photocontrols.

ConnectLED™

ConnectLED is a software application that communicates with the AreaMax via BLE (Bluetooth Low Energy) to:

- commission /decommission the fixture
- create brightness settings
- upload custom dimming algorithms
- activate motion detection (pending).

Run ConnectLED on a Windows 7 laptop with a licensed dongle at a range of 150' om the AreaMax.

CONNECTLED™ SOFTWARE

37598451	25 UNIT LICENSE PACK*
41058338	PC DONGLE
39140436	AMAX, BLE REMOTE (commission/decommission only)

*Delivery methods for ConnectLED may vary depending on quantity and preference. Please contact your sales agent for current information.

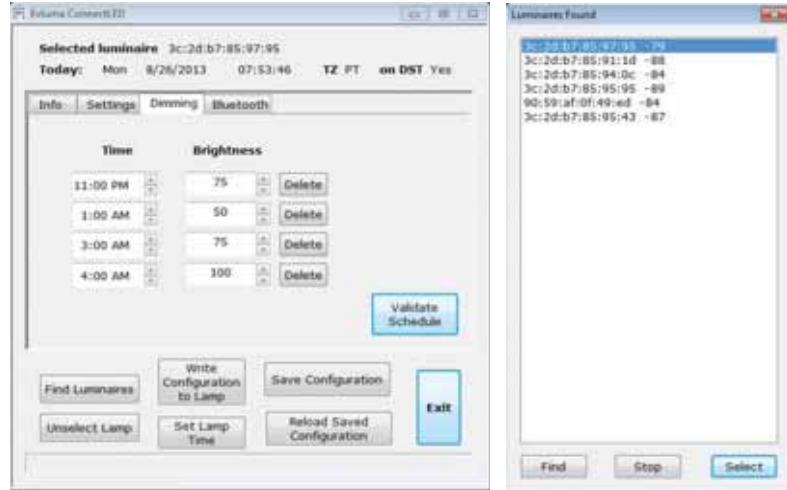

Setting the dimming schedule for a luminaire in ConnectLED

Thermal Management

Evluma designed the AreaMax with two critical things in mind: maximum lumens per watt and maximum cooling. Low temperatures are key to LED long life and brightness. Critical components were selected for their minimum thermal resistance and paired with a custom light engine and casting design effectively executing this strategy.

In addition, LED life is assured by thermal management protection circuitry that controls current levels to the LEDs based on temperature. Temperature is measured at the LED package, often referred to as the solder point temp, or T_{SP}. At 65°C the fixture begins to cut back on the current to the LEDs to either maintain, or reduce the temperature back down to 65°C.

Warranty

The AreaMax carries Evluma's standard 5 year warranty.

Isofootcandle Lines at 25 ft mounting heights

70W AreaMax = Solid Lines

40W AreaMax = Dashed Lines

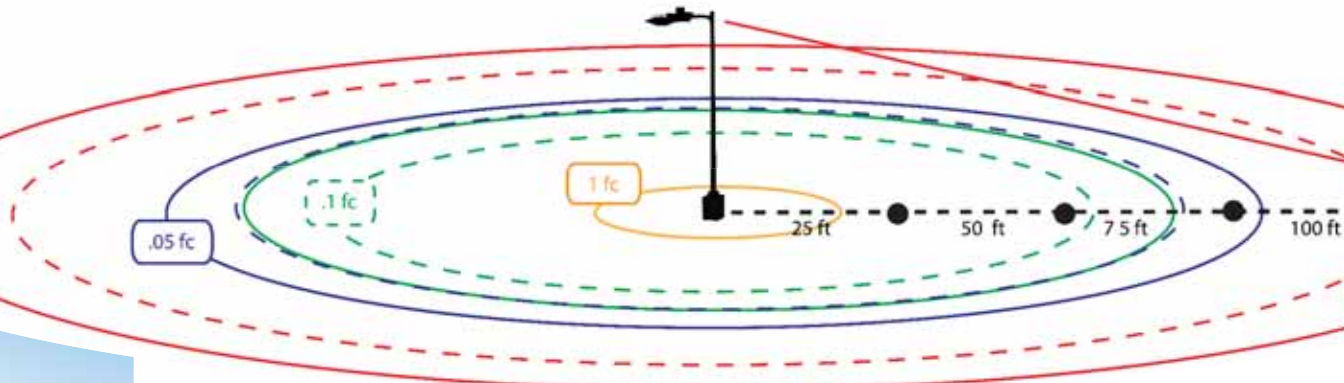

A M A X - - - - -

FC Part 15
Class A



PRODUCT ID	WATTS	PERFORMANCE CODES	PHOTOMETRIC TYPE	LENS
AMAX = AreaMax	40 = 40 watts**	4K-6 5K-6	V = Type V	C = Full Cut-Off D = Dome
	70 = 70 watts	5K-6	V = Type V	C = Full Cut-Off D = Dome



PERFORMANCE CODES 40W

Code	CCT	CRI	Lumens	LED mA	BUG	IES File Numbers
4K-6 (D)	4500K	>70	>3000	700mA	B2-U2-G1	ITL75686+75689
5K-6 (D)	5500K	>65	>3500	700mA	B2-U2-G1	ITL75687+75690
4K-6 (C)	4500K	>70	>3000	700mA	B1-U0-G1	ITL75688+75691
5K-6 (C)	5500K	>65	>3500	700mA	B1-U0-G1	ITL75688+75690

PERFORMANCE CODES 70W

5K-6 (D)	5500K	>65	>6000	700mA	B3-U2-G2	report pending
5K-6 (C)	5500K	>65	>6000	700mA		report pending

ELECTRICAL PERFORMANCE

- 120-277 VAC 50/60 Hz (.32 Amps at 120VAC)
 - Power Factor >95%
 - THD <10% at 120 VAC, <20% at 277 VAC
 - **Replaceable** high capability surge protection for 20kV/10kA per IEEE/ANSI C62.42.2 - 2002. Location Category C-High
-
- 89076826 SURGE BOARD REPLACEMENT KIT, AREAMAX
- <1/2 W Off-state power (not including photocontrol)

COMBINED PAYBACK MODEL

	40W AreaMax	100W HPS
Purchase Price (MSRP)	\$225.00	\$90.00
Asset Life	20 years	10 years
Maintenace Cost: 10 years	\$0.00	\$750.00***
Energy Cost: 10 years @ .08/KwHr	\$132.48	\$331.20
Cost of Ownership: 10 years incl. 3% finance charge for 5 years	\$414.42	\$1357.74
Annualized Cost: 10 years	\$41.44	\$135.77
Monthly Rental Rate @ Break Even	\$3.45	\$11.31
***HID photocontrol and lamp service calls		
Simple Payback at HPS rental rate	3.05 years	

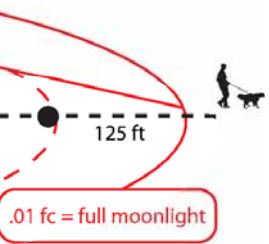

L70 at >100,000 Hours.
 **DLC Qualified. RoHS Compliant
 Temperature rated at -40°C to 40° C
 LM-79, IES & In-Situ Files Available
 Thermal Management Protection Circuitry
 Made in the USA of US and Imported Parts



Photocontrol and mounting arm are not included.

POLAR CANDELA DISTRIBUTION

Vertical Plane (1) and Horizontal Cone (2) through maximum candela

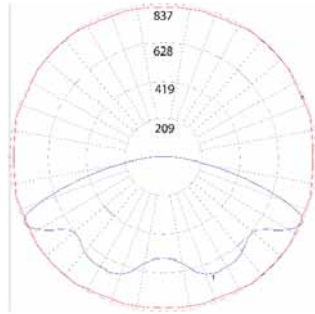
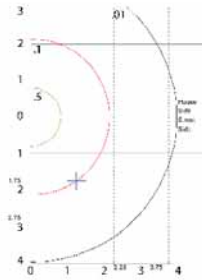

40W Dome Lens: Max Candela: 837 at 65° Angle
.01 fc at 4 25' mtg htgs B2-U2-G1. ITL75687

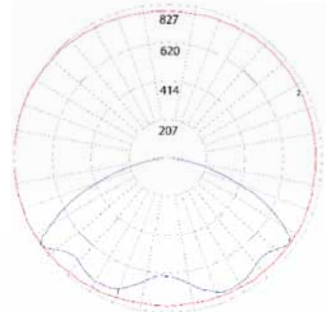
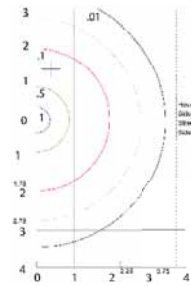

40W Flat (Full-Cutoff Lens) Max Candela: 811 at 55° Angle
.01 fc at over 3 25' mtg htgs. B1-U0-G1. ITL75688.

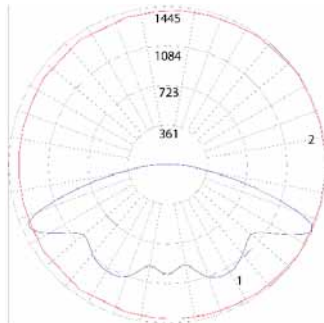
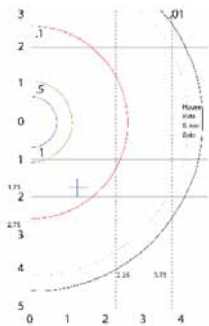

70W Dome Lens: Max Candela: 1445 at 65° Angle
.01 fc at >4 25' mtg htgs B3-U2-G2. Final Tests Pending

DIMENSIONS

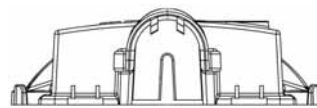
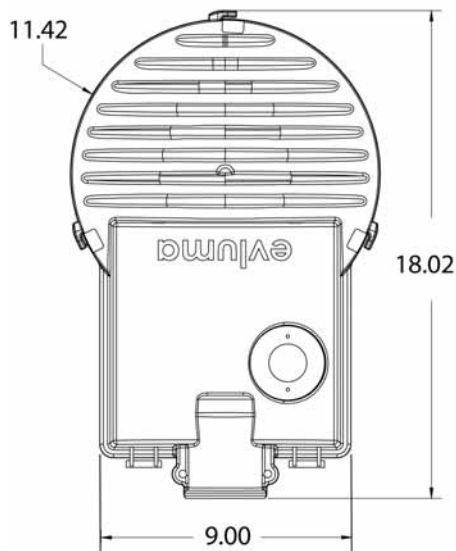

accepts 2" or 1 1/4" arm

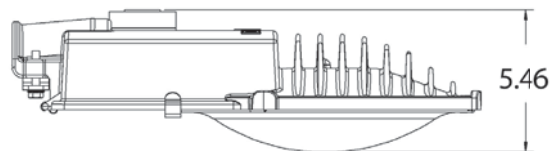

CONSTRUCTION

- 16-32 long life LEDs: CREE XTEAWT
- high efficiency reflective optics
- textured & tempered glass lens
- die cast aluminum housing with grey powder coat
- accepts 2" or 1 1/4" arm
- performs to IP66 standards
- factory installed 66" pigtail
- weight = 9lbs